

# ADO

## 880 SERİ PVC PROFİL SİSTEMİ

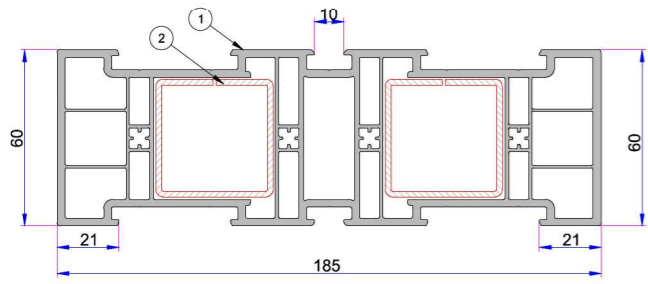

1. Hebeschiebe Kasa Profili  
P.A.930.1000.600.0.BC.01  
2. Destek Sacı (40x40)  
2 mm - 34022 - 20110

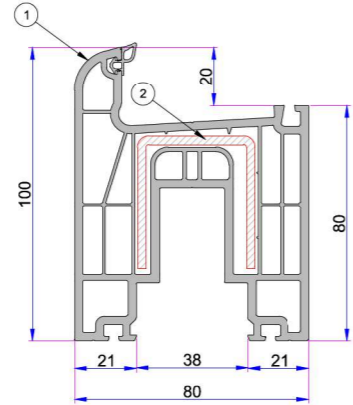

1. Hebeschiebe Kanat Profili  
P.A.930.2000.600.0.BC.01  
2. Destek Sacı (45x40x45)  
2,5 mm - 34022 - 25001

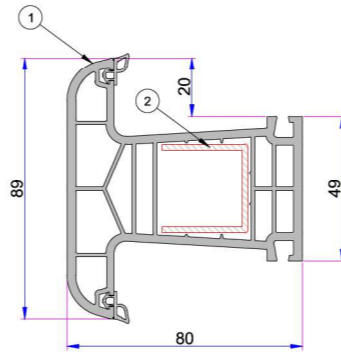

1. Hebeschiebe Orta Kayıt Profili  
P.A.860.3000.600.0.BC.01  
2. Destek Sacı (29x30x29)  
1,5 mm - 34022 - 15002  
2,0 mm - 34022 - 20002

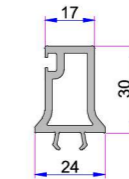
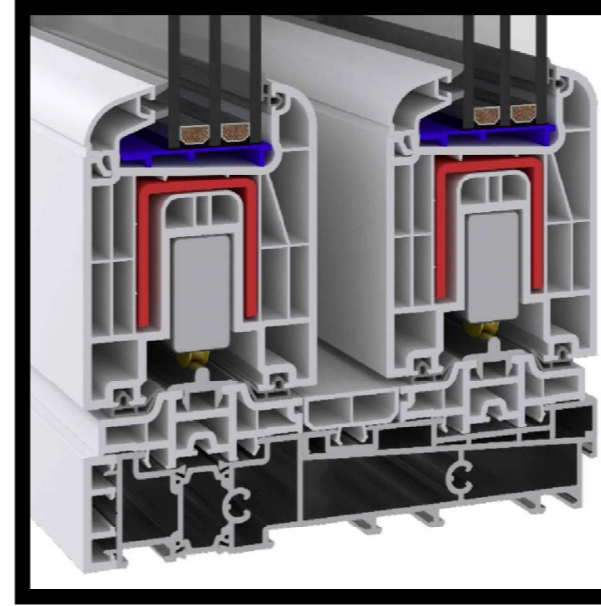

Hebeschiebe Kasa Orta Adaptörü  
P.A.900.6503.600

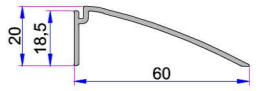

20mm Eşik İç Profili  
(Yeni Yapılacak)

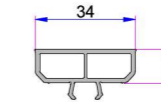

Hebeschiebe Orta Kanal Kapama  
P.A.930.6505.600

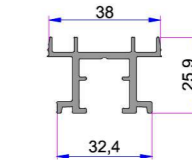

Kasa Üst Ray Alüminyum  
AD16-019

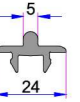

Kanat Üst Ray Alüminyum  
AD16-020

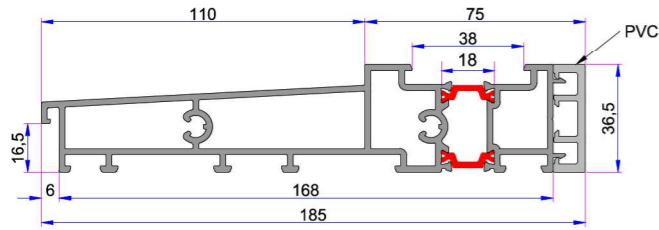

Hebeschiebe İç Kısmı PVC Isı Yalıtımlı Alm. Eşik Profili  
AD16-026

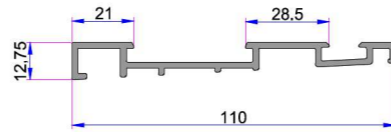

Alüminyum Eşik İkinci Kanat Ray  
AD16-025

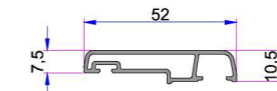

Kasa Dış Pervaz Profili  
AD16-022

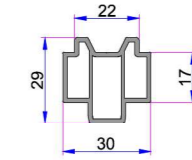

Sabit Kanat Yataklama Alüminyum  
AD16-021

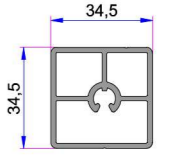

Kasa İç Çektirme Alm. (8cm)  
AD16-023

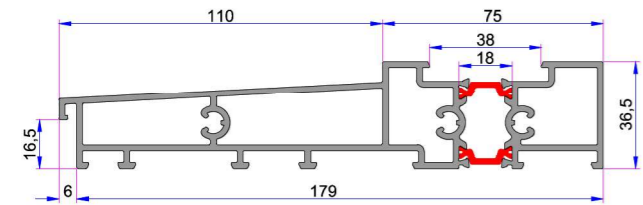

Hebeschiebe Isı Yalıtımlı Alm. Eşik Profili  
AD16-027

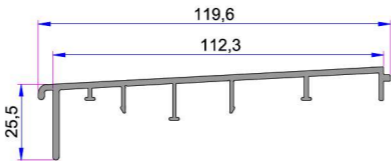

Hebeschiebe Alüminyum Eşik Kapama  
AD16-024

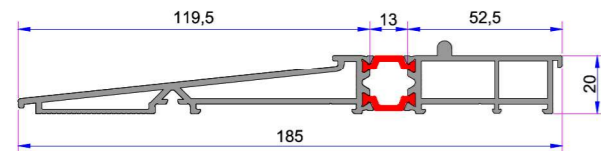

Hebeschiebe Alüminyum Isı Yalıtımlı Eşik 20mm  
(Yeni Yapılacak)

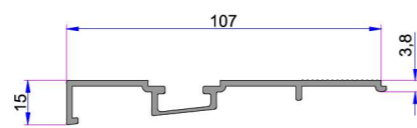

Hebeschiebe Alüminyum Eşik İkinci Kanat Ray  
(Yeni Yapılacak)

PVC Ve Alm. Alt Kasa Köşe Birleştirme Parçası  
21238.0000.0

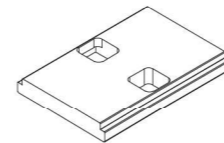

Çift kanat Alt Orta Ara Sızdırmazlık  
21240.0001.L

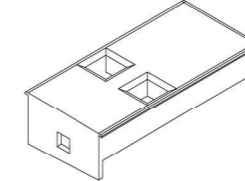

PVC Kasa Birleşim Sızdırmazlık Contası

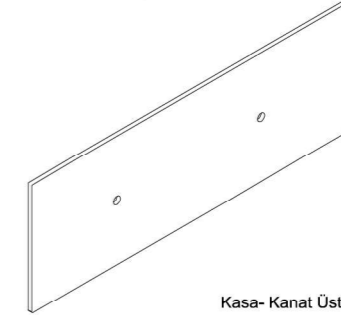

PVC Kasa Birleşim Sızdırmazlık Contası

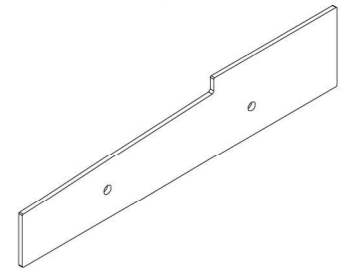

Çoklu kanat Alt Orta Ara Sızdırmazlık  
21240.0001.0

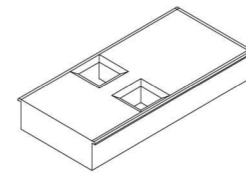

Çift kanat Alt Orta Ara Sızdırmazlık  
21240.0000.R

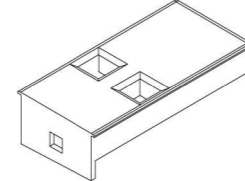

Kasa- Kanat Üst Orta Sızdırmazlık Parçası  
21239.0000.0

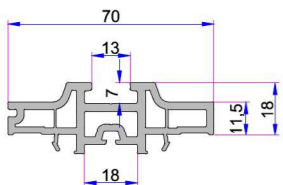
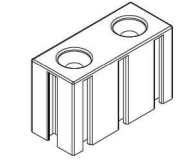

Hebeschiebe Kanat ve Ray Adaptörü  
P.A.930.6500.600

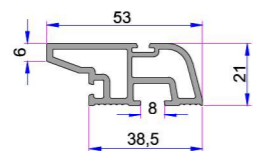

Hebeschiebe Kanat Ara Bindirme Profili  
P.A.930.6504.600

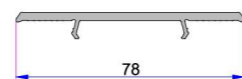

Hebeschiebe Kanat Arka ve  
Kasa Kanal Kapama  
P.A.930.6506.600

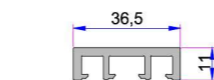

Alüminyum Eşik Arka Kapama (PVC)  
P.A.930.6502.600.0.0019

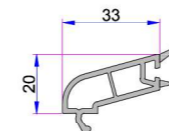

Çift Cam Çıtası (24mm)  
P.A.800.4200.600.0.HC

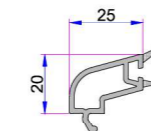

Üçlü Cam Çıtası (32mm)  
P.A.800.4500.600.0.HC

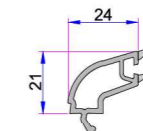

Üçlü Cam Çıtası (32mm)  
P.A.750.4204.600.0.HC

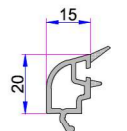

Üçlü Cam Çıtası (42mm)  
P.A.800.4600.600.0.HC